

Coffee System

Aura Traditional espresso machine, 3 Maestro groups, Steamair

ITEM # _____

MODEL # _____

NAME # _____

SIS # _____

AIA # _____

602529 (AURA3SA)

Traditional espresso machine, 3 Maestro groups, 15,6 liter boiler, 3 independent control boxes with 4 programmable dosing program

Short Form Specification

Item No. _____

The professional semi-automatic AURA line owns all the technical features of a high-end traditional espresso machine, offering the perfect harmony of aesthetics and performance. With its modern design of stainless steel and chrome, the AURA displays an assertive silhouette underlined with LED lighting of the tray grill and around the electronic control boxes with touchscreen interface for an intuitive programming. AURA is dedicated to users familiar with volumetric commands that address high performance and consistency in the extraction process. The MAESTRO thermo-regulated brew groups are fitted with the EASYLOCK system that help locking and sealing the portafilter with minimal effort. The AURA line offers a set of advanced technologies that warrant an outstanding coffee extraction quality and a strong hot water/steam power.

Main Features

- Steamair milk auto-frother programmable outlet.
- Automatic cleaning cycle.
- Programmable water.
- The professional semi-automatic AURA line owns all the technical features of a high-end traditional espresso machine, offering the perfect harmony of aesthetics and performance.
- Manual Steamglide lever.
- Modern design of stainless steel and chrome, the AURA displays an assertive silhouette underlined with LED lighting of the tray grill and around the electronic control boxes with touchscreen interface for an intuitive programming.
- AURA is dedicated to users familiar with volumetric commands that address high performance and consistency in the extraction process.
- The MAESTRO thermo-regulated brew groups are fitted with the EASYLOCK system that help locking and sealing the portafilter with minimal effort.
- 3 Maestro groups.
- 3 independent control boxes with 4 programmable dosing selection with Dosamat[®] self recognition of portafilter, start/stop, shot time display.
- Electronic pre infusion.
- Double paneled cup warmer with large capacity.
- USB interface for update.

Construction

- Stainless steel body.
- PID (proportional-integral-derivative) Temperature control: a precise controller algorithm system that gives consistency and accuracy to brewing temperature management system.
- 15.6 liter boiler.
- Easylock portafilter.
- RS-232 protocol for computer/cashier interface.

Included Accessories

- 1 of Aura filter holder for one cup PNC 871008
- 3 of Aura filter holder for two cups PNC 871009

Optional Accessories

- Doser Coffee Grinder, flat, 65mm PNC 602543
- Doser Coffee Grinder, flat, 75mm PNC 602544
- Grind-on-demand Coffee Grinder, flat, 75mm PNC 602546

APPROVAL: _____

- Aura filter holder for one cup PNC 871008
- Aura filter holder for two cups PNC 871009
- Side milk refrigerator 8 liter nominal capacity for up to 4 liter milk containers PNC 871014
- Side milk refrigerator 8 liter nominal capacity for up to 4 liter milk containers with digital display PNC 871015
- Filter for one cup, 12 gr PNC 871017
- Filter for two cups, 18 gr PNC 871018
- Stainless steel knock box drawer PNC 871019

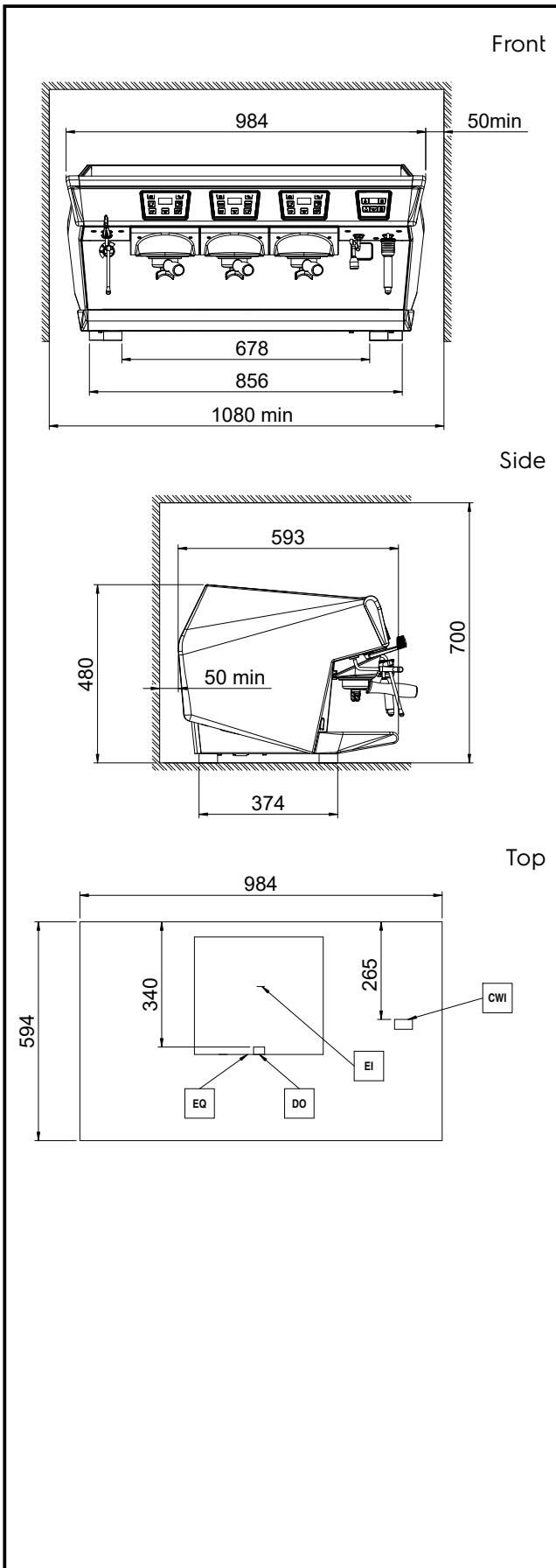

Electric

Supply voltage:

602529 (AURA3SA) 400 V/3N ph/50 Hz

Electrical power max.:

4.8 kW

Plug type:

Cable without plug

Water:

Cold water temperature

(min/max): 5 / 60 °C

Key Information:

External dimensions, Width: 984 mm

External dimensions, Depth: 592 mm

External dimensions, Height: 490 mm

Net weight: 83 kg

Shipping volume: 0.83 m³

Sustainability

Current consumption: 7.2 Amps